

Article number: 03489008

Description: Fluro Rod end EAL 8D-NIRO

Note: 8

Measures

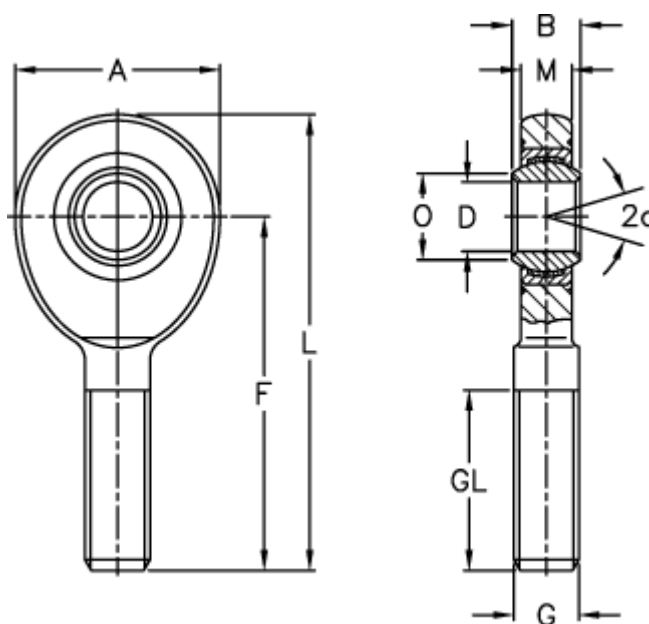

A	= 24	L	= 54
a (degrees)	= 15	M	= 6
B	= 8	O	= 10.2
D	= 8	Static drive kN	= 7.4
Dynamic drive (kN)	= 7	Weight	= 28
F	= 42		
g	= M8		
GL	= 22		